

1(a). In 1958 Matthew Meselson and Franklin Stahl conducted an experiment that supported the theory that DNA replication occurred due to semi-conservative replication.

Fig. 25.1 shows semi-conservative replication of part of a DNA molecule.

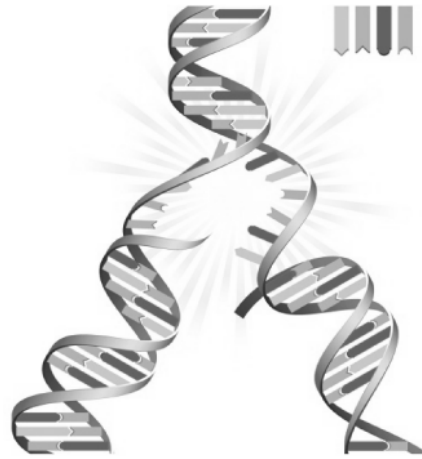

Fig. 25.1

Explain what is meant by the term *semi-conservative replication*.

[2]

(b). The genome of the plant *Arabidopsis thaliana*, the mouse-ear cress, was the first plant genome to be sequenced. Its genome was found to be relatively small and contains 5 chromosomes and 135 million base pairs.

Calculate the number of adenine nucleotides present in this genome if 20% of the nucleotides are guanine.

Show your working.

number of adenine nucleotides [2]

2. Adult stem cells divide by mitosis to produce replacement stem cells as well as cells that can differentiate into specialized cells.

The immortal strand hypothesis suggests a mechanism for the production of both replacement stem cells and cells that can differentiate.

Fig. 21.1 is an outline of the immortal strand hypothesis.

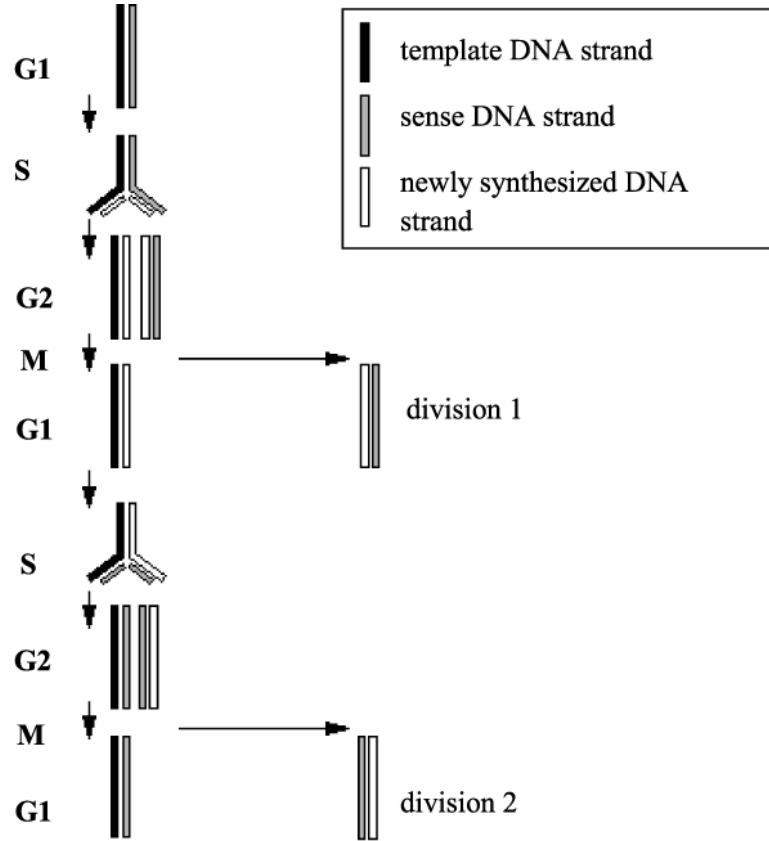

Fig. 21.1

- Cells that retain the template strand do not differentiate and remain stem cells.
- Cells without the template strand can differentiate.

(i) Name the processes happening at S and M in Fig. 21.1.

S

M

[1]

(ii) Name two **enzymes** that are essential for the process happening at S.

1.

2.

[2]

(iii) According to the immortal strand hypothesis, if a single stem cell undergoes **ten** cycles of division, how many new stem cells and how many cells capable of differentiating will be produced?

You should assume that all cells divide at the same rate.

Number of stem cells -----

Number of cells that can differentiate -----

[2]

3(a). A gene has to be expressed if it is to affect the phenotype of an organism. The first stage in gene expression is the production of a messenger RNA copy of the gene.

* Describe how a messenger RNA copy of a gene is produced.

[6]

(b). One mechanism for controlling gene expression in cells uses small, double stranded pieces of RNA known as siRNA.

- 1 siRNA molecules are introduced into the cell.
- 2 The siRNA molecules are combined with a protein complex called the RNA induced silencing complex (RISC) and one of the siRNA strands is destroyed.
- 3 The other strand remains bound to RISC and acts as a guide. RISC is now said to be activated.
- 4 This strand binds to complementary sequences on messenger RNA molecules in the cytoplasm causing them to be destroyed.

Fig. 36.1 shows the sequence of events for this mechanism.

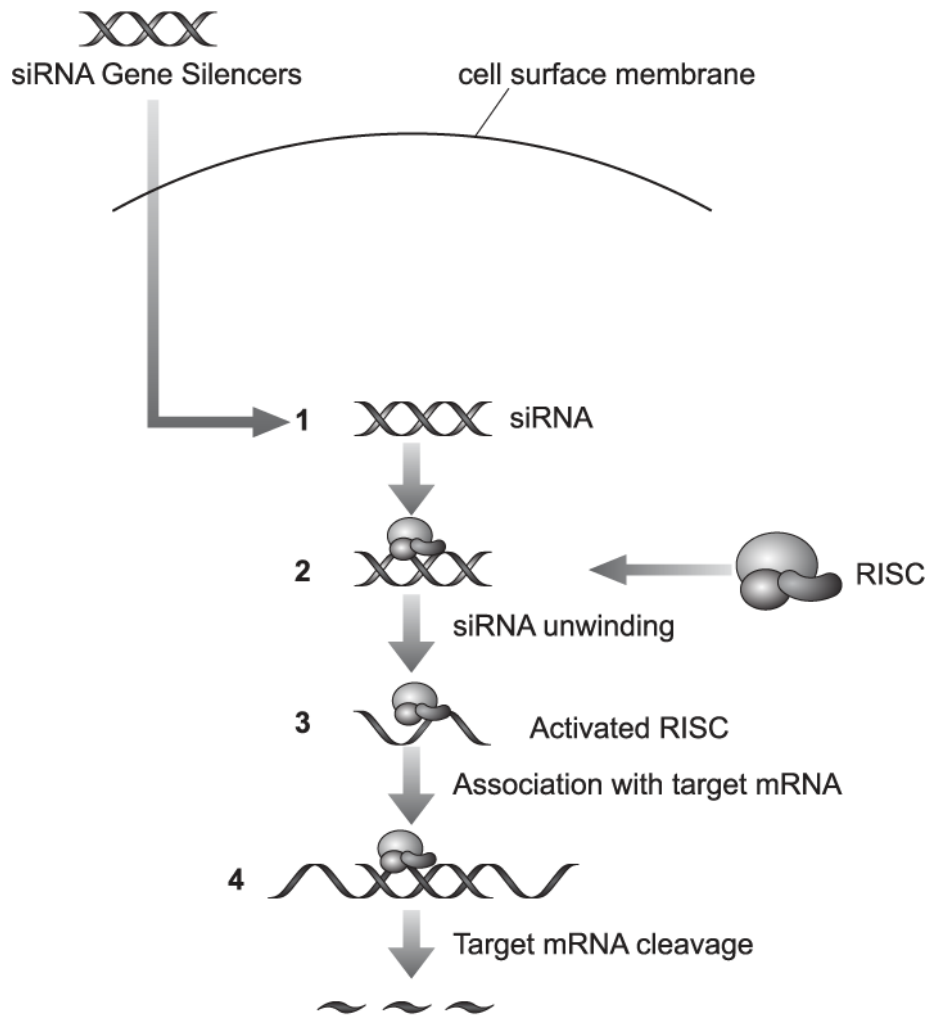

Fig. 36.1

(i) An RNA strand on an activated RISC has the following sequence.

On the line above, write out the sequence that activated RISC would bind to on the mRNA molecule.

[1]

(ii) What type of reaction is carried out by activated RISC on the bonds in the mRNA molecule?

[1]

(iii) Clinical trialling is being carried out on the use of siRNA as an anti-viral therapy for the treatment of Hepatitis C infections.

Suggest how siRNA could prevent the spread of a virus within a person infected by the Hepatitis C virus.

[3]

4. The GNA11 gene codes for a protein that is involved in cell signalling.

(i) Outline the changes in DNA which would lead to a faulty version of the GNA11 gene.

[1]

(ii) Suggest how the faulty version of the GNA11 gene is formed and suggest how the faulty GNA11 causes the development of ocular melanoma.

[3]

5(a). This question is based on the Advanced Notice article **CHANGES IN THE NUCLEUS THAT LEAD TO CANCER**, which is an insert.

There are several different types of gene mutation. In substitution mutations one nucleotide is exchanged for another which produces a different base sequence.

Fig.1.1 represents part of a gene. The letters X and Y indicate two nucleotides that have been changed by a mutation.

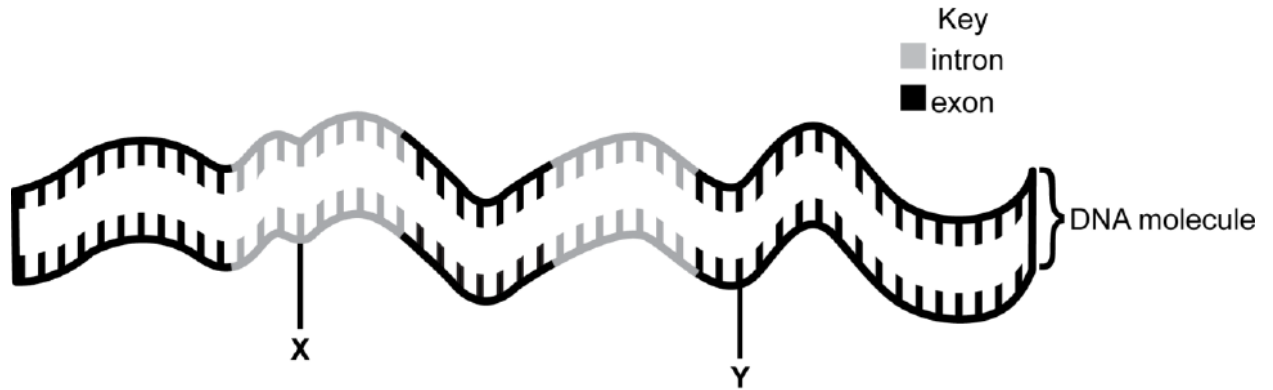

Fig. 1.1

(i) Name one genetic disease caused by a **substitution** mutation. [1]

(ii) Explain why a substitution mutation at point X will **not** result in a genetic disease. [2]

(iii) The substitution mutation at point Y on the DNA molecule resulted in a change from the triplet AGA to AGG. This did **not** result in a genetic disease. [2]

Suggest why **this** substitution mutation did **not** result in a genetic disease.

(b). Extract 2 of the Advanced Notice article describes the methylation of DNA.

Methyl groups are added to the cytosine in cytosine-guanine dinucleotides (CpGs) by the enzyme DNMT.

Fig.1.2 shows the structure of a section of DNA that has been methylated.

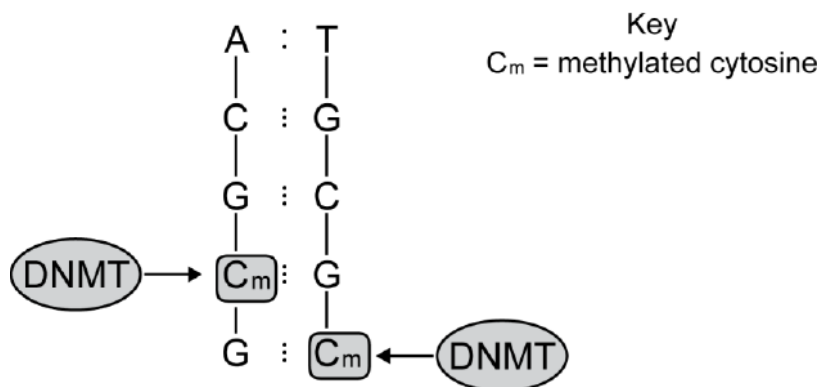

Fig. 1.2

(i) A nucleotide containing cytosine and a nucleotide containing guanine can be bonded together in two ways:

- in a dinucleotide
- in a base pair.

How are these bonds different?

[2]

(ii) Fig. 1.3 shows a sugar bonded to a molecule of cytosine which has been methylated by DNMT.

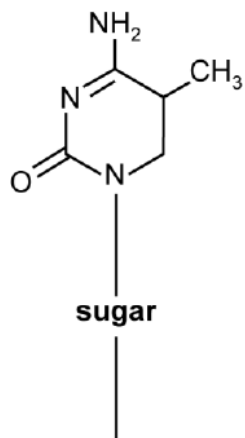

Fig. 1.3

Name the sugar to which the methylated cytosine is attached.

----- [1]

- (iii) The addition of a methyl group to cytosine increases the chances of the molecule being **deaminated** and converted to thymine.

On Fig.1.3, circle the part of the molecule that would be removed by deamination.

[1]

(c). In human DNA, the frequency of CpG sites across the genome varies.

In the human genome:

- analysis of the base content of human DNA shows that 21% of the bases present are cytosine.
- the **overall** frequency of CpG sites in the human genome is 0.01.
- in regions of the genome known as **promoters**, the frequency of CpGs is approximately 0.6.
- deamination of cytosine at CpG sites converts the cytosine to **thymine**.

(i) Using the information about the human genome, calculate the **expected** frequency of a CpG site in human DNA.

Show your working. Give your answer to **three** significant figures.

Answer = _____ [2]

(ii) By analysing the information about the human genome and your answer to (i), explain why the frequency of CpG sites is low in some regions but high in others.

----- [4]

6. Duchenne’s muscular dystrophy (**DMD**) is an inherited disease.

- It is caused by a mutation in a gene that codes for a protein called **dystrophin**.
- Dystrophin is present and functioning in normal muscle cells.
- The malfunctioning or absence of this protein causes muscle weakness that progresses over time.

(i) Explain how a gene mutation can lead to a protein malfunctioning.

[5]

(ii) Suggest why **DMD** cannot be detected by amniocentesis or chorionic villus sampling.

[1]

7(a). Some scientists think that the structure of DNA can be improved. Scientists in Florida have been attempting to re-design DNA.

Fig. 3.1 shows a section of one of their designs.

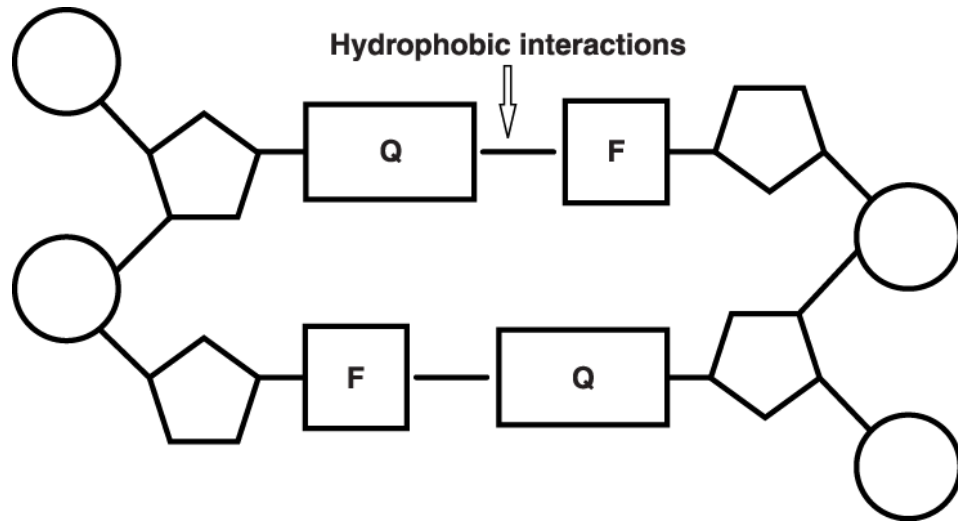

Fig. 3.1

State **two** differences and **one** similarity between natural DNA and the re-designed DNA shown in Fig. 3.1.

Differences

1

2

Similarity

(b). During the cell cycle, DNA is replicated.

(i) Why is DNA replication a semi-conservative process?

[1]

(ii) A student attempted to describe the process of DNA replication to a friend.

The student wrote the following description, but the friend noticed three errors in the description.

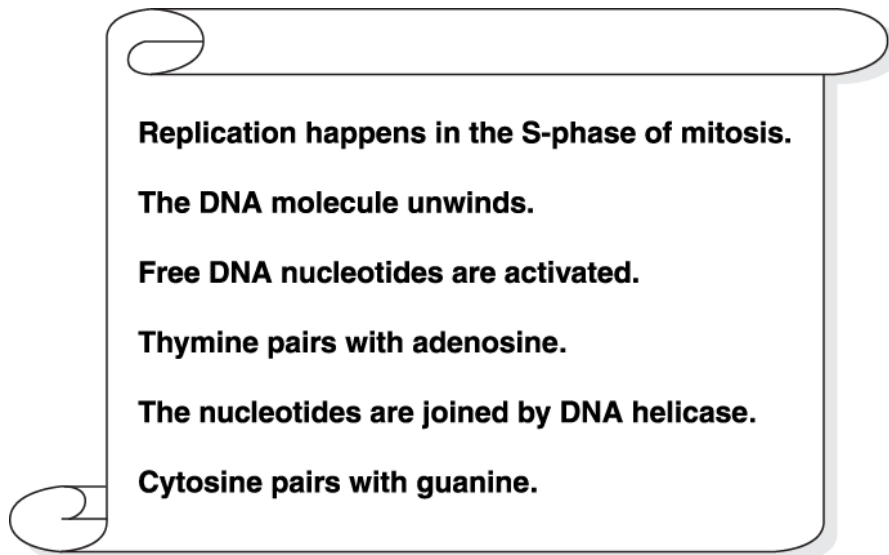

Choose **three words** from the description that are errors and write a suitable word or term to replace each one.

1. *Error*

Replacement

2. *Error*

Replacement

3. *Error*

Replacement

[3]

(iii) In addition to DNA replication, other events also take place in the cell cycle. Two phases of the cell cycle are G_1 and G_2 .

Outline the processes that take place in these two phases.

G_1

G_2

[4]

8(a).

Fig. 4 shows a simplified diagram of part of a DNA molecule.

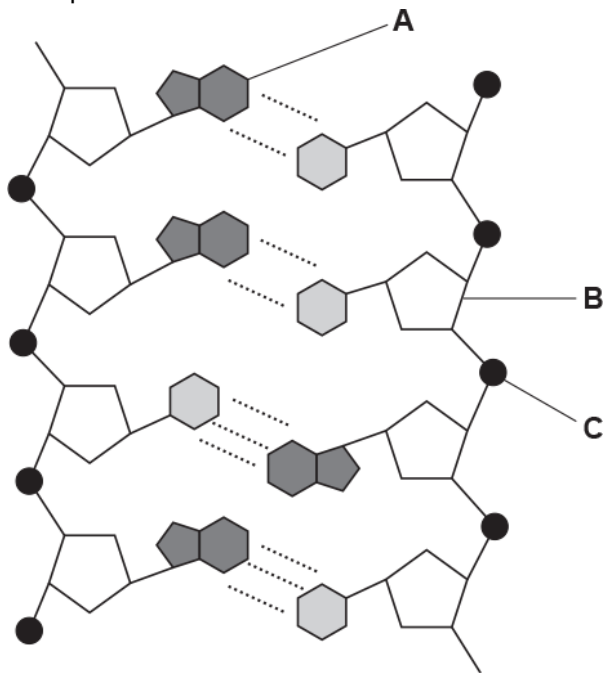

Fig. 4

(i) Identify the parts of the DNA molecule labelled A to C in Fig. 4.

A
 B
 C

[3]

(ii) The table below shows the results of an analysis of the base composition for each strand of a DNA molecule.

Complete the table by adding the missing values for strands 1 and 2.

DNA strand	Percentage of each base			
	A	C	G	T
strand 1		35	22	
strand 2	18			

[2]

(b). Hydrogen bonding is central to the function of nucleic acids.

Explain how hydrogen bonding contributes to the process of semi-conservative replication of DNA.

[2]

9(a). The molecule shown in Fig. 21 is one of the nucleotides found in ribonucleic acid (RNA).

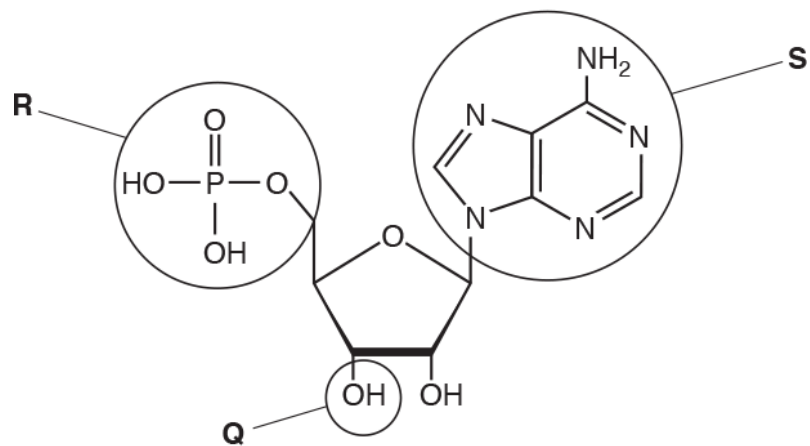

Fig. 21

Parts of the molecule have been labelled Q, R and S.

Which part(s) of the molecule labelled in Fig. 21

(i) can form a phosphodiester bond with other nucleotides?

----- [1]

(ii) can join with phosphate groups to form ATP?

----- [1]

(iii) can form hydrogen bonds with another nucleotide?

----- [1]

(b). Describe how a nucleotide found in deoxyribonucleic acid would differ from the nucleotide shown in Fig. 21.

----- [1]

(c). The sequence of nucleotides in DNA provides the genetic code for synthesising proteins.

The genetic code can be described as universal because it is the same in almost all organisms.

Name and describe **other** features of the genetic code.

[4]

(d). DNA is an extremely stable molecule and has been extracted from Egyptian mummies and fossils.

(i) What feature of the DNA molecule provides stability?

[1]

(ii) Messenger RNA (mRNA) is the type of nucleic acid that carries the genetic information on DNA from the nucleus to the site of protein synthesis.

Unlike DNA, mRNA is relatively unstable and has a short life-span.

Suggest **one** advantage of mRNA being relatively unstable with a short life-span.

[1]

10.

(i) The roots of bean plants form nodules due to infection by the nitrogen-fixing bacteria, *Rhizobium*.

In response to infection by *Rhizobium*, bean plant nodule cells produce protein called leghaemoglobin.

Researchers wanted to find out more about three genes that code for leghaemoglobin.

They used RNA interference (RNAi) to inhibit the production of leghaemoglobin using miRNA. They measured the relative transcript level of the leghaemoglobin genes of bean plants treated with miRNA (RNAi plants) and those of untreated bean plants.

The results are shown in Table 1.

Name of leghaemoglobin gene	Relative transcript level of gene	
	Untreated plants	RNAi plants
LjLb1	3.5	0.085
LjLb2	4.0	
LjLb3	2.0	0.045

Table 1

Transcript levels for gene LjLb2 in the RNAi plants were reduced by 97.4% compared with the untreated plants.

Calculate the relative transcript level for LjLb2 in the RNAi plant.

Show your working.

Answer = [3]

END OF QUESTION PAPER

Question			Answer/Indicative content	Marks	Guidance
1	a		Any 2 from: two identical molecules / helices, (of DNA) produced (1) (each made up of) 1, original / parent / old, strand and one new strand (1) original / parent / old, strands, act as template / described (1)	2	
	b		Any 2 from: 30% adenine (1) $(135 \text{ million} \times 2) = 270 \text{ million} / 100) \times 30$ (1) 81 million (1)	2	ALLOW correct answer with no working for 2 marks ALLOW $270\,000\,000 \times 0.3$ ALLOW 1 mark for $(135 \text{ million} / 100) \times 30 = 40.5 \text{ million}$
			Total	4	
2		i	S (semi-conservative) DNA replication AND M mitosis	1	
		ii	Any two from, (DNA) polymerase (DNA) helicase (1) (DNA) ligase (1)	2	ALLOW in any order
		iii	Number of stem cells 1 (1) Number of cells which can differentiate 1023 (1)	2	
			Total	5	

Question		Answer/Indicative content	Marks	Guidance	
3	a	<p>* Level 3 (5–6 marks) A detailed description, including at least one statement from each section in the correct sequence (from 1, 2 and then 3), showing knowledge and understanding of the production of mRNA is given and all steps are in the correct order.</p> <p><i>There is a well-developed line of reasoning which is clear and logically structured. The information presented is relevant and substantiated.</i></p> <p>Level 2 (3–4 marks) Description includes at least two correct statements in the correct sequence but there is some repetition or irrelevant information (e.g. about translation).</p> <p><i>There is a line of reasoning presented with some structure. The information presented is in the most-part relevant and supported by some evidence.</i></p> <p>Level 1 (1–2 marks) One correct statement is made which include points from any of the sections shown in the guidance.</p> <p><i>The information is basic and communicated in an unstructured way. The information is supported by limited evidence and the relationship to the evidence may not be clear.</i></p> <p>0 marks No response or no response worthy of credit.</p>	6	<p>Sections indicate possible scientific points and the expected sequence of the answer.</p> <p>Section 1</p> <ul style="list-style-type: none"> RNA polymerase binds to the DNA reference to the promoter region (for binding) reference to transcription factors <p>OR DNA unwinding (by DNA helicase)</p> <p>Section 2</p> <ul style="list-style-type: none"> reference to RNA, nucleotides / bases, pairing with bases on, template strand reference to complementary base pairing / numbers of hydrogen bonds forming correct reference to base pairings <p>DNA RNA A U T A C G G C</p> <ul style="list-style-type: none"> reference to RNA polymerase, catalysing / AW, formation of, phosphodiester bonds / AW <p>Section 3</p> <ul style="list-style-type: none"> reference to termination / stop sequence reference to DNA rewinding / RNA polymerase leaving the DNA strand reference to removal of introns from primary RNA / formation of, mature / messenger RNA 	
	b	i	ACGGGAAGGGCCCGAGCACGGA UGCCCUUCCCGGGCUCGUGCCU	1	
		ii	hydrolysis	1	IGNORE 'cleavage'

Question			Answer/Indicative content	Marks	Guidance
		iii	Any 3 from: (activated) RISC, cleaves / AW, viral mRNA no viral proteins made no, viral particles / AW, assembled <i>idea that</i> no new cells are infected	3	IGNORE 'virus cannot spread' as this is given in the question
			Total	11	
4		i	<i>idea of</i> changes in, base / nucleotide / triplet, sequence	1	
		ii	mutation / AW, to proto-oncogene (leads to) faulty, receptor / growth factor (leads to) uncontrolled cell division	3	ALLOW forms oncogene DO NOT ALLOW (cell) signalling molecule because this is referenced in the stem
			Total	4	

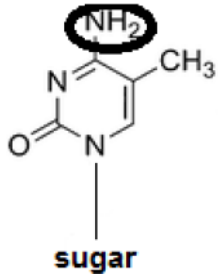
Question			Answer/Indicative content	Marks	Guidance
5	a	i	Sickle cell anaemia / PKU / Cystic Fibrosis	1	DO NOT ALLOW Huntington's ALLOW alternative correct suggestions
		ii	(X in intron) <i>idea that</i> code in this region does not appear in mature mRNA (1) <i>idea that</i> introns are transcribed but edited out (1)	2	ALLOW an explanation that this region does not code for amino acids
		iii	<i>idea that</i> genetic code is degenerate (1) <i>idea that</i> new triplet codes for an amino acid with a similar R group (1) no change in the tertiary structure of the protein (1)	2	ALLOW a description - some amino acids have more than one triplet ALLOW idea of 'little or no change' if second mark point is awarded ALLOW three dimensional protein structure DO NOT ALLOW 'no change in protein structure' without further qualification since 'structure' is given in the stem of the question
	b	i	(dinucleotide bond is) phosphodiester bond / covalent bond / formed by a condensation reaction (1) (base pair is) (3) hydrogen bonds (1)	2	
		ii	deoxyribose (1)	1	DO NOT ALLOW 'pentose' or 'ribose' as they are told that DNMT methylates DNA
		iii	 sugar	1	
	c	i	0.044 = 2 marks (1)(1)	2	If answer is incorrect look for: 0.21 x 0.21 OR (21/100) x (21/100) OR 4.4% for max 1 mark

Question		Answer/Indicative content	Marks	Guidance
	ii	<p><i>Idea that overall frequency is much lower than expected (1)</i></p> <p><i>reason for 0.01 / low frequency</i> more risk of gene mutations occurring (1) <i>idea of base substitution (1)</i></p> <p><i>reason for 0.6 / high frequency</i> <i>idea that promotor requires more methylation sites than other regions (1)</i></p> <p><i>idea that promoters regulate gene expression (1)</i></p> <p><i>idea that RNA polymerase binds to promoter when it is unmethylated (1)</i></p> <p>methylation allows genes to be switched off when not required (1)</p>	4	DO NOT ALLOW the reverse argument as this is given in the case study
		Total	15	

Question			Answer/Indicative content	Marks	Guidance
6		i	<p>1 <i>idea that</i> (causes) a change in, a DNA, triplet / code / sequence; DNA triplet code /</p> <p>2 (leading to) a change in, mRNA / codon;</p> <p>3 (leading to) a change in, tRNA / anticodon (at ribosome);</p> <p>4 (leading to) a different, amino acid / primary structure / sequence of amino acids;</p> <p>5 (different amino acids have) different R groups;</p> <p>6 different bond(ing) in (protein) tertiary structure;</p> <p>7 <i>idea that</i> (change) leads to (protein) changing its shape / described;</p> <p>8 consequence for protein action described;</p>	5	<p>ACCEPT idea of 'wrong' or 'incorrect' for 'different' or 'changed' throughout</p> <p>1. ACCEPT mutation might lead to a stop codon inserted</p> <p>2. CREDIT idea of a triplet or 3 mRNA bases</p> <p>6. ACCEPT 'bonding / folding altered in tertiary structure'</p> <p>DO NOT CREDIT 'no protein made'</p> <p>8 CREDIT examples e.g. (enzyme) no enzyme substrate complex forms, (antibody) variable region not binding to antigen, (protein channel) no hydrophilic R groups lining channel e.g. mutation might lead to a stop codon inserted</p>
		ii	<p>DMD is not a chromosome mutation;</p> <p>(karyotypes) (amniocentesis or CVS) detect, chromosome mutations / described;</p>	1	<p>IGNORE 'DMD is a gene mutation' (as this is given in the stem of the question)</p> <p>CREDIT description e.g. changes in chromosome number or structure.</p>
			Total	6	

Question		Answer/Indicative content	Marks	Guidance
7	a	<p><i>Differences</i> Different, (nitrogenous / organic), bases;</p> <p>only one bond between bases;</p> <p>bases, joined / AW, by hydrophobic interactions;</p> <p><i>Similarity (1 mark maximum)</i> complementary bases (in both); (both contain) nucleotides / bases; 5 carbon sugar / deoxyribose, (in both); phosphate (in both);</p> <p>antiparallel strands / 3' - 5' and one 5' - 3';</p>	3	<p>Mark the first answer on each line. If the answer is correct and an additional answer is given that is incorrect or contradicts the correct answer then = 0 marks</p> <p>ACCEPT Q and F instead of, A and T / C and G OR only has 2 (different) bases instead of 4</p> <p>CREDIT (bases joined by) hydrophobic interactions rather than hydrogen bonds</p> <p>IGNORE reference to purines & pyrimidines</p> <p>ACCEPT sugar-phosphate backbone</p> <p>ACCEPT strands run in opposite directions</p> <p>Examiner's Comments</p> <p>This question equally addressed AO1 and AO2.</p> <p>Most candidates confidently identified correct similarities and differences.</p>

Question			Answer/Indicative content	Marks	Guidance						
	b	i	(new DNA molecule) consists of one new strand and one old / original / parent, strand;	1	DO NOT CREDIT DNA strand consists of one old and one new strand Examiner's Comments Several candidates incorrectly referred to the new DNA molecule as a 'strand' or stated that "half the DNA is from the old and half from the new" without making reference to the new molecule comprising one original / parent strand and one new / daughter strand. Some candidates appeared to think that only half the (exposed) molecule replicated when it unzipped (as in the 'Y-shaped' diagram often drawn) and then it joined back up again.						
		ii	<table style="width: 100%; border: none;"> <tr> <td style="text-align: center;"><i>Error</i></td> <td style="text-align: center;"><i>Replacement</i></td> </tr> <tr> <td>(S phase of) Mitosis</td> <td>(S phase of) interphase;</td> </tr> <tr> <td>adenosine helicase</td> <td>adenine; polymerase;</td> </tr> </table>	<i>Error</i>	<i>Replacement</i>	(S phase of) Mitosis	(S phase of) interphase;	adenosine helicase	adenine; polymerase;	3	Mark the first answer on each line. If the answer is correct and an additional answer is given that is incorrect or contradicts the correct answer then = 0 marks Examiner's Comments Many candidates stated that DNA unwinding was an error to be replaced with 'DNA unzips'. It should be realised that the unwinding of DNA is essential in replication. Most identified that adenosine should be replaced with adenine.
<i>Error</i>	<i>Replacement</i>										
(S phase of) Mitosis	(S phase of) interphase;										
adenosine helicase	adenine; polymerase;										
		iii	<p>G_1 (2 marks maximum) (more) protein, synthesised / made; (more) cytoplasm volume increases; cell, grows / increases in size; (more) organelles, produced / grow and divide / replicate;</p> <p>G_2 (more) organelles, produced / grow and divide / replicate; energy stores, increase / AW; <i>idea of</i> (DNA) proofreading / checkpoint;</p>	4	Examiner's Comments Many candidates seemed unclear as to what specifically happens in each of G_1 and G_2 phases, and repeated their descriptions in each part. Some failed to gain credit for stating that organelles grow rather than <u>grow and divide</u> .						
			Total	11							

Question			Answer/Indicative content	Marks	Guidance																			
8	a	i	<p>A adenine / <u>purine</u> ✓</p> <p>B <u>deoxyribose</u> / pentose ✓</p> <p>C phosphate ✓</p>	3	<p>Examiner's Comments</p> <p>(a)(i) was well answered but with a few candidates stating nitrogenous base only for A.</p>																			
		ii	<table border="1"> <thead> <tr> <th rowspan="2">DNA strand</th> <th colspan="4">Percentage of each base</th> </tr> <tr> <th>A</th> <th>C</th> <th>G</th> <th>T</th> </tr> </thead> <tbody> <tr> <td>strand 1</td> <td>25</td> <td>(35)</td> <td>(22)</td> <td>18</td> </tr> <tr> <td>strand 2</td> <td>(18)</td> <td>22</td> <td>35</td> <td>25</td> </tr> </tbody> </table> <p style="text-align: right;">✓✓</p>	DNA strand	Percentage of each base				A	C	G	T	strand 1	25	(35)	(22)	18	strand 2	(18)	22	35	25	2	<p>2 rows correct = 2 marks 1 row correct = 1 mark</p> <p>Examiner's Comments</p> <p>Many candidates achieved full marks for (a)(ii). Errors appeared to be random and showed some candidates did not read the heading of percentage and that each row had to add up to 100.</p>
DNA strand	Percentage of each base																							
	A	C	G	T																				
strand 1	25	(35)	(22)	18																				
strand 2	(18)	22	35	25																				
	b		<p>hydrogen bonds broken by <u>helicase</u> (to separate the strands) ✓</p> <p>hydrogen bonds between free nucleotide and exposed (template) base ✓</p> <p>2 bonds between A & T and 3 between C & G ✓</p> <p>complementary, bases / base pairing ✓</p> <p>joins, DNA strands / polynucleotides / old strand and new strand ✓</p>	2 max	<p>DO NOT ALLOW hydrolyses hydrogen bond</p> <p>Examiner's Comments</p> <p>(b) was well answered with most candidates appreciating that complementary base pairing referred to the hydrogen bonding between bases. Some answers discussed DNA replication without focusing on the role of hydrogen bonding.</p>																			
			Total	7																				

Question			Answer/Indicative content	Marks	Guidance
9	a	i	Q <u>and</u> R ✓	1	<p>Both required for 1 mark</p> <p>Examiner's Comments This question addressed both AO1 and AO2 with a biochemical theme around nucleic acids and the genetic code aimed at assessing the ability of candidates to apply knowledge in context. Q21(a)(i) Two responses were required here for 1 mark and few candidates gave both Q and R needed to gain credit. However, over half of the candidates gave correct responses for parts (a)(ii) and (iii).</p>
		ii	R ✓	1	<p>Examiner's Comments This question addressed both AO1 and AO2 with a biochemical theme around nucleic acids and the genetic code aimed at assessing the ability of candidates to apply knowledge in context. Q21(a)(i) Two responses were required here for 1 mark and few candidates gave both Q and R needed to gain credit. However, over half of the candidates gave correct responses for parts (a) (ii) and (iii).</p>
		iii	S ✓	1	<p>Examiner's Comments This question addressed both AO1 and AO2 with a biochemical theme around nucleic acids and the genetic code aimed at assessing the ability of candidates to apply knowledge in context. Q21(a)(i) Two responses were required here for 1 mark and few candidates gave both Q and R needed to gain credit. However, over half of the candidates gave correct responses for parts (a) (ii) and (iii).</p>

Question		Answer/Indicative content	Marks	Guidance
	b	<i>idea that</i> an oxygen atom would be removed from , the OH group / part of molecule labelled Q ✓	1	<p>IGNORE different nitrogenous base</p> <p>ALLOW would contain deoxyribose instead of ribose</p> <p>Examiner's Comments The most common correct response in Q21(b) was the ALLOW in additional guidance with reference to ribose and deoxyribose, rather than the absence of the O atom on the part of the molecule labelled Q.</p>
	c	<p>degenerate ✓</p> <p>AND (because) <i>idea that</i> there is more than one codon for (most) amino acids ✓</p> <p>triplet (code) ✓</p> <p>AND (because) <i>idea that</i> three bases are needed to code for one amino acid ✓</p> <p>non-overlapping ✓</p> <p>AND <i>idea that</i> the sequence is read so that each base is only part of one , codon / triplet ✓</p>	4 max	<p>IGNORE reference to universal (code)</p> <p>The description must be linked to the correct named feature</p> <p>ALLOW description without feature provided it is not contradicted</p> <p>ALLOW triplet (code) anywhere in response for 1 mark if mentioned in correct context</p> <p>Examiner's Comments In Q21(c), high attaining candidates gained maximum marks demonstrating good understanding of the degenerate and non-overlapping nature of the genetic code. Some candidates, however, described the molecular structure of DNA or lacked detail of the genetic code, whereby marks could not be awarded.</p>

Question		Answer/Indicative content	Marks	Guidance
	d i	double helix ✓ (polynucleotide) strand / sugar-phosphate backbone , held by strong , covalent / phosphodiester , bonds ✓	1 max	IGNORE reference to addition of histones DO NOT ALLOW alpha (α) helix DO NOT ALLOW strong hydrogen bonds Examiner's Comments Candidates achieved marks to Q21(d)(i) by describing the double helix and there were few references to phosphodiester bonds, or the sugar-phosphate 'backbone'.
	ii	<i>idea that</i> proteins that are no longer required do not continue to be synthesised ✓	1	ALLOW <i>idea that</i> mRNA can be broken down quickly to stop over production of protein IGNORE reference to RNA mutations Examiner's Comments Q21(d)(ii) proved challenging. Stronger candidates understood the idea that breaking down mRNA would prevent unnecessary production of proteins so would save energy and resources within the cell. References to mutations in mRNA or recycling did not gain credit.
		Total	10	

Question			Answer/Indicative content	Marks	Guidance
10		i	0.104 ✓✓✓	3	<p>If answer is incorrect or missing, a maximum of 2 marks can be given for intermediate stages as follows:</p> <p>one mark for working such as</p> <ul style="list-style-type: none"> • $4.0 - ((97.4 / 100) \times 4.0)$ • 4 & 0.026 • $100 - 97.4 = 2.6\%$ with 2.6% of 4.0 = 0.104 <p>one mark for incomplete calculation</p> <ul style="list-style-type: none"> • 3.896 <p>one mark for correct answer but not quoted to 3dp e.g. 0.10</p> <p><u>Examiner's Comments</u></p> <p>Candidates should provide answers that are to the same number of decimal places for other data in the same column. In this case the answer should be given to 3 decimal places.</p>

Question	Answer/Indicative content	Marks	Guidance
ii	<p>inhibits <u>translation</u> of mRNA ✓ (miRNA) binds at a <u>complementary</u> site (on mRNA) ✓ argonaute protein, breaks/cleaves, the mRNA strand ✓</p> <p>AVP ✓</p>	3 max	<p>IGNORE references to 'miRNA inhibits mRNA' as this is given in the stem of the question</p> <p>DO NOT ALLOW references to inhibiting transcription</p> <p>Further detail e.g.</p> <ul style="list-style-type: none"> • double stranded precursor binds to, dicer / endonuclease protein • dicer cuts precursor (into short segments) • dicer cuts precursor • (short double stranded) miRNA binds to argonaute protein • RNA induced silencing complex (RISC) formed • small sections of mRNA can be translated but will not result in formation of a, functional / complete, protein <p>Examiner's Comments</p> <p>Some candidates did not score marks in this questions due to poor expression; for exampling muddling mRNA and miRNA in their answers. Others gave answers that related to enzyme inhibition which did not relate to the question. This area of the specification is new and examiners observed many answers that were lacking depth and detail.</p> <p>Exemplar 2</p> <p>Double stranded RNA binds to a dicer which cleaves the RNA to around 200 nucleotide lengths. An argonaute protein binds to one of the RNA strands - RNA strand has a complementary sequence of nucleotides which will have complementary base pairing to the target mRNA. It binds from between miRNA and mRNA, miRNA cleaves the mRNA and prevents it from being translated. (see part 1)</p>

Question	Answer/Indicative content	Marks	Guidance
	iii miRNA less, precise / specific (than siRNA) ✓	1	<p>DO NOT ALLOW 'miRNA is more accurate'</p> <p>ALLOW miRNA will bind to more than one mRNA</p> <p>ALLOW miRNA will inhibit, all / more, of the leghaemoglobin genes</p> <p>Examiner's Comments</p> <p>Again some less able candidates discussed enzyme inhibition rather than the difference between precision of miRNA and siRNA.</p> <p>Exemplar 3</p> <p><i>miRNA is more specific acting - that it will only inhibit one specific gene - siRNA affects it all to affect - siRNA is more specific - miRNA is able to inhibit several of the genes at once / siRNA may only inhibit one.</i></p>
	Total	7	